

Introduction The GS+4NH3 range of sensors are non-biased ammonia sensors great for fixed and portable detectors.

Key Features: Unbiased, fast response and recovery, robust environment performance, high stability.

Performance Characteristics	
Output signal	40 ± 15 nA / ppm
Typical Baseline Range (pure air)	±2 ppm NH3 equivalent
T90 Response Time	< 40 seconds
Measurement Range	0 - 300 ppm
Maximum Overload	500 ppm
Linearity	Linear
Repeatability	±5%
Recommended Load Resistor	10 Ohms
Resolution (Electronics dependent)	2ppm

Environmental Details	
Temperature Range Continuous	-40°C to +50°C
Pressure Range	800 to 1200 mbar
Operating Humidity Range	15% to 90% RH

Important Note:

All performance data is based on conditions at 20°C, 50%RH and 1 atm, using DD Scientific recommended circuitry.

Sensor performance is temperature dependent, and please contact DD Scientific for temperature performance other than 20°C.

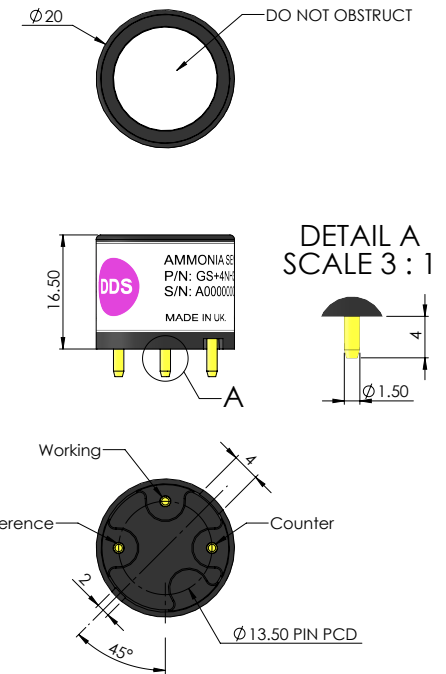

Product Dimensions
All dimensions in mm
All tolerances ±0.15 mm

Lifetime Details

Long Term Output Drift	< 10% per annum
Recommended Storage Temp	0°C to 20°C
Expected Operating Life	> 24 months in air
Standard Warranty	12 months from date of dispatch

Cross - Sensitivity Data

GAS	CONC.	GS+4NH3-300
Carbon Monoxide	500 ppm	0 ppm
Hydrogen Sulphide	25 ppm	30 ppm
Sulphur dioxide	20 ppm	-6 ppm
Nitrogen Dioxide	5 ppm	-5 ppm
Nitric Oxide	50 ppm	0 ppm
Hydrogen	100 ppm	0 ppm
Ethanol	100 ppm	0 ppm
Carbon Dioxide	5000 ppm	0 ppm

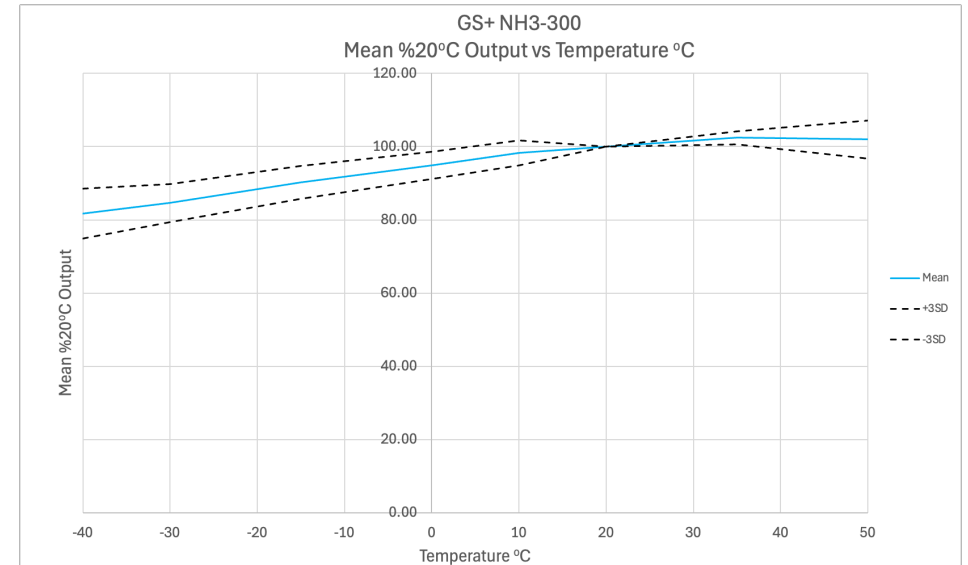

Poisoning:

DD Scientific sensors are designed to operate in a wide range of harsh environments and conditions. However, it is important that exposure to high concentrations of solvent vapours is avoided, both during storage, fitting into instrument and operation. When using sensors on printed circuit boards (PCB's), degreasing agents should be used prior to the sensor being fitted.

Please note gluing or soldering direct to the pins of DD Scientific Ltd gas sensors will void warranty, please use PCB sockets when connecting DD Scientific sensors.

Intrinsic Safety Data

Maximum at 500 ppm	<0.1 mA
Maximum o/c Voltage	1.3 V
Maximum s/c Current	<1.0 A

WARNING: By the nature of the technology used, any electrochemical gas sensor offered by DD Scientific can potentially fail to meet specification without warning. Although DD Scientific Ltd makes every effort to ensure the reliability of our products of this type, where life safety is a performance requirement of the product, we recommend that all sensors and instruments using these sensors are checked for response to gas before use.

Every effort has been made to ensure the accuracy of this document at the time of printing. In accordance with the company's policy of continued product improvement DD SCIENTIFIC Limited reserves the right to make product changes without notice. No liability is accepted for any consequential losses, injury or damage resulting from the use of this document or from any omissions or errors herein. The data is given for guidance only. It does not constitute a specification or an offer for sale. The products are always subject to a program of improvement and testing which may result in some changes in the characteristics quoted. As the products may be used by the client in circumstances beyond the knowledge and control of DD SCIENTIFIC Limited, we cannot give any warranty as to the relevance of these particulars to an application. It is the clients' responsibility to carry out the necessary tests to determine the usefulness of the products and to ensure their safety of operation in a particular application. Performance characteristics on this data sheet outline the performance of newly supplied sensors. Output signal can drift below the lower limit over time.